

Details of Connector

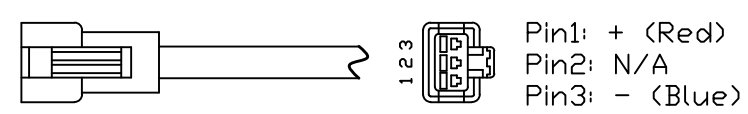

Connector Type: SMR-03V-B (Light Side)  
SMP-03V-BC (Power Supply Side)

Specification:

MODEL	WLDL-210L15-W/-B/-G/-UV	-Y/-R/-IR850/-IR940
Wavelength(nm)	6500K/470/525/390	590/625/850/940
Power Supply	DC24V/10.0(W)	DC24V/6.7(W)
Weight	130g	

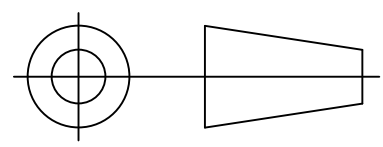
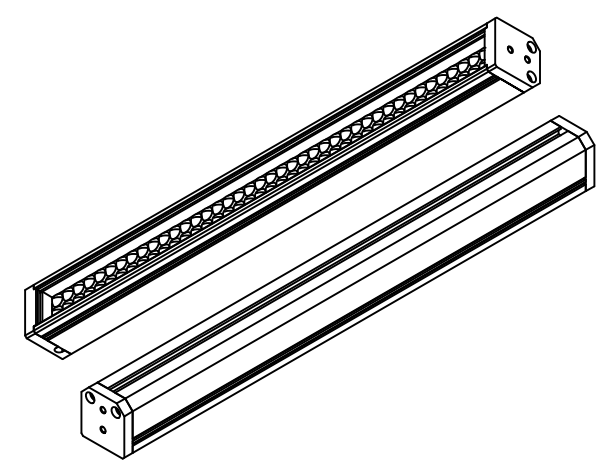

Itemref	Quantity	Material: AL	Article No./Reference		
Designed by Y.KOTANI	Checked by T.ONO	Approved by - date JULY-20,2014	Filename WLDL-210L15	Date JULY-20,2014	Scale 1/1
WAVECREST(SH)			WLDL-210L15-USER		
			WLDL-210L15-0000	Edition VER.1.0	Sheet 1